

## Playhouse - brown

Product type DOH-6103KW-10

### Basic information

Age category	0 - 10 years
Minimum area	3,93 m x 3,93 m
Equipment measurements	0,93 m x 0,93 m x 1,54 m
Free fall height:	0 m
Max. number of users:	3
Fall zone: EN 1177	null
Certificate of Compliance:	ČSN EN 1176-1 ed.2 +A1:2024

### Material

Metal units - structural steel  
Plastic units - HDPE

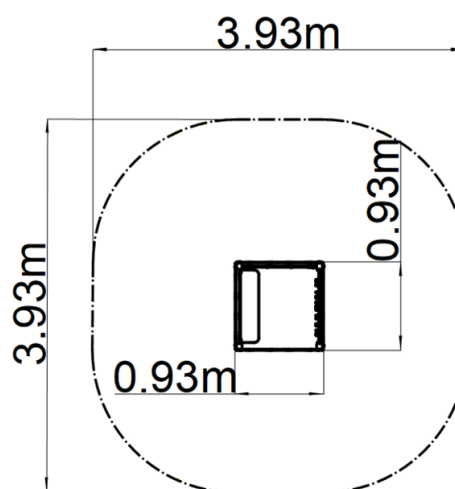

### Finish

Duplex powder coated with coat curing  
Hot-dip galvanizing

### Description

The support structure of the playhouse is made of structural steel which is protected against corrosion by zinc coating, resulting in a very prolonged service life of the workout elements, or duplex powder coated with coat curing according to RAL to prevent corrosion. These structures are anchored to concrete footings. All other metallic elements are also zinc coated or duplex powder coated with coat curing according to RAL to prevent corrosion.

The benches and side walls are made from high quality HDPE plastic (high density coloured polyethylene, which is characterised by high colour stability, UV resistance but mainly safety as it doesn't break and therefore there is no danger of injury to children by sharp fragments). All fastening material is galvanized or stainless steel.

### Equipment

1x battlements from HDPE, 2x side wall, 1x bench, abacus.